







Single Phase Hybrid Solar Inverter



PAE-EVO-3500

-  Built-in 120A Solar Charger
-  Wide MPPT Range 120-500V
-  Workable with Generator
- DUAL** Dual AC Output
- BMS** Support Lithium/Lead-acid Battery
-  Inverter Running without Battery
-  Detachable Dust Cover
-  WiFi Monitoring

System Diagram

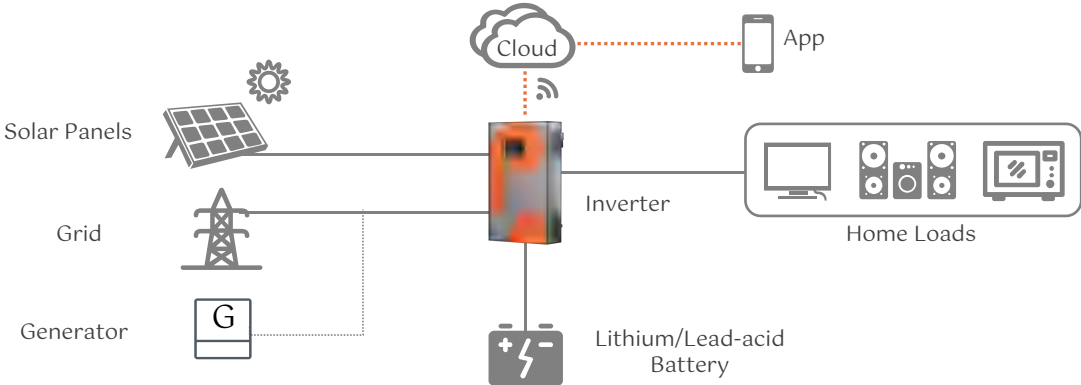

Specifications

Model	PAE-EVO-3500
AC Input	
Rated Input Voltage (VAC)	208 / 220 / 230 / 240; L + N + PE
Voltage Range (VAC)	90~280±3 (normal mode); 170~280±3 (UPS mode)
Frequency (Hz)	50 / 60 (Auto Adaptive)
AC Output	
Rated Capacity (kW)	3.5
Surge Power (kVA)	6
Voltage (VAC)	208 / 220 / 230 / 240
Power Factor (PF)	1
Frequency	50/60Hz±0.1%
Switch Time (ms)	10 (normal mode) / 10 (UPS mode)
Wave Form	Pure Sine Wave
Overload Capacity (Battery Mode)	60s@102%~110% load; 10s@110%~130% load; 3s@130%~150% load; 0.2s@>150% load
Max. Efficiency (Battery Mode)	93%@24VDC
Parallel Quantity	NA
Charger (PV / AC)	
Solar Charger Type	MPPT
Max PV Input Current / Input Power	12A / 4000W
MPPT Range@Operating Voltage (VDC)	120~450
Max PV Open Circuit Voltage (VDC)	500
Max PV Charge Current (A)	120
Max AC Charge Current (A)	120
Max. Charge Current (PV + AC) (A)	120
Battery	
Rated Voltage (VDC)	24
Floating Charge Voltage (VDC)	27
Overcharge Protection (VDC)	31
Battery Type	Lithium and Lead-acid
Interface	
HMI	LCD
Interface	RS485 / RS232 / USB / Dry Contact
Monitoring	WiFi (Optional)
General Data	
Ingress Protection	IP20
Operating Temperature	-10℃ ~ 50℃
Relative Humidity	5% ~ 95% (Non-condensing)
Storage Temperature	-15℃ ~ 60℃
Net Weight (kg)	8.7
Dimensions (W*H*D)	510*306*115mm (without bracket)
Max. Operating Altitude	4000m (Derating above 1000m)