

# Product datasheet

Specifications



## TeSys F contactor - 3P (3 NO) - AC-3 - <= 440 V 630 A - coil 220 V AC

LC1F630M7

⚠ To be discontinued on: Dec 31, 2023

⚠ To be discontinued

### Main

Range	TeSys
Range Of Product	TeSys F
Product Or Component Type	Contactors
Device Short Name	LC1F
Contactors Application	Resistive load Motor control
Utilisation Category	AC-3 AC-1 AC-4
Poles Description	3P
[Ue] Rated Operational Voltage	<= 1000 V AC 50/60 Hz <= 460 V DC
[Uc] Control Circuit Voltage	220 V AC 40...400 Hz
[Ie] Rated Operational Current	1000 A (at <40 °C) at <= 440 V AC AC-1 630 A (at <55 °C) at <= 440 V AC AC-3

### Complementary

[Uimp] Rated Impulse Withstand Voltage	8 kV
[Ith] Conventional Free Air Thermal Current	1000 A (at 40 °C) 1250 A
Rated Breaking Capacity	5040 A conforming to IEC 60947-4-1
[Icw] Rated Short-Time Withstand Current	5050 A 40 °C - 10 s 4400 A 40 °C - 30 s 3400 A 40 °C - 1 min 2200 A 40 °C - 3 min 1600 A 40 °C - 10 min
Associated Fuse Rating	1000 A gG at <= 440 V 630 A aM at <= 440 V
Average Impedance	0.12 mOhm - Ith 1000 A 50 Hz
[Ui] Rated Insulation Voltage	1000 V conforming to IEC 60947-4-1 1500 V conforming to VDE 0110 group C
Power Dissipation Per Pole	120 W AC-1 48 W AC-3
Overvoltage Category	III
Power Pole Contact Composition	3 NO

<b>Motor Power Kw</b>	335 kW at 380...400 V AC 50/60 Hz (AC-3) 375 kW at 415 V AC 50/60 Hz (AC-3) 400 kW at 440 V AC 50/60 Hz (AC-3) 400 kW at 500 V AC 50/60 Hz (AC-3) 450 kW at 660...690 V AC 50/60 Hz (AC-3) 450 kW at 1000 V AC 50/60 Hz (AC-3) 200 kW at 220...230 V AC 50/60 Hz (AC-3) 100 kW at 400 V AC 50/60 Hz (AC-4)
<b>Control Circuit Voltage Limits</b>	Operational: 0.85...1.1 Uc 40...400 Hz (at 55 °C) Drop-out: 0.25...0.5 Uc 40...400 Hz (at 55 °C)
<b>Mechanical Durability</b>	5 Mcycles
<b>Inrush Power In Va</b>	1650 VA, 40...400 Hz cos phi 0.9 (at 20 °C)
<b>Hold-In Power Consumption In Va</b>	22 VA, 40...400 Hz cos phi 0.9 (at 20 °C)
<b>Maximum Operating Rate</b>	1200 cyc/h 55 °C
<b>Operating Time</b>	40...80 ms closing 100...200 ms opening
<b>Connections - Terminals</b>	Control circuit: screw clamp terminals 1 cable(s) 1...4 mm <sup>2</sup> flexible without cable end Control circuit: screw clamp terminals 2 cable(s) 1...4 mm <sup>2</sup> flexible without cable end Control circuit: screw clamp terminals 1 cable(s) 1...4 mm <sup>2</sup> flexible with cable end Control circuit: screw clamp terminals 2 cable(s) 1...2.5 mm <sup>2</sup> flexible with cable end Control circuit: screw clamp terminals 1 cable(s) 1...4 mm <sup>2</sup> solid without cable end Control circuit: screw clamp terminals 2 cable(s) 1...4 mm <sup>2</sup> solid without cable end Power circuit: bar 2 cable(s) - busbar cross section: 60 x 5 mm Power circuit: bolted connection
<b>Tightening Torque</b>	Control circuit: 1.2 N.m Power circuit: 58 N.m
<b>Mounting Support</b>	Plate
<b>Heat Dissipation</b>	20 W
<b>Motor Power Range</b>	250...500 kW at 380...440 V 3 phases 110...220 kW at 200...240 V 3 phases 250...500 kW at 480...500 V 3 phases
<b>Motor Starter Type</b>	Direct on-line contactor
<b>Contactor Coil Voltage</b>	220 V AC standard
<b>Standards</b>	EN 60947-1 IEC 60947-4-1 JIS C8201-4-1 IEC 60947-1 EN 60947-4-1
<b>Product Certifications</b>	LROS (Lloyds register of shipping) CB UL RMRoS CSA ABS BV DNV RINA UKCA
<b>Compatibility Code</b>	LC1F
<b>Control Circuit Type</b>	AC at 40...400 Hz

## Environment

<b>Ip Degree Of Protection</b>	IP20 front face with shrouds conforming to IEC 60529 IP20 front face with shrouds conforming to VDE 0106
<b>Protective Treatment</b>	TH
<b>Ambient Air Temperature For Operation</b>	-5...55 °C
<b>Ambient Air Temperature For Storage</b>	-60...80 °C

<b>Permissible Ambient Air Temperature Around The Device</b>	-40...70 °C
<b>Height</b>	304 mm
<b>Width</b>	309 mm
<b>Depth</b>	255 mm
<b>Operating Altitude</b>	3000 m without derating
<b>Net Weight</b>	18.6 kg

## Packing Units

<b>Unit Type Of Package 1</b>	PCE
<b>Number Of Units In Package 1</b>	1
<b>Package 1 Height</b>	29.46 cm
<b>Package 1 Width</b>	36.83 cm
<b>Package 1 Length</b>	46.99 cm
<b>Package 1 Weight</b>	18.78 kg
<b>Unit Type Of Package 2</b>	P06
<b>Number Of Units In Package 2</b>	4
<b>Package 2 Height</b>	80 cm
<b>Package 2 Width</b>	80 cm
<b>Package 2 Length</b>	60 cm
<b>Package 2 Weight</b>	82.232 kg

## Contractual warranty

<b>Warranty</b>	12 months
-----------------	-----------

## Sustainability

**Green Premium™ label** is Schneider Electric's commitment to delivering products with best-in-class environmental performance. Green Premium promises compliance with the latest regulations, transparency on environmental impacts, as well as circular and low-CO<sub>2</sub> products.

**Guide to assessing product sustainability** is a white paper that clarifies global eco-label standards and how to interpret environmental declarations.

[Learn more about Green Premium >](#)

[Guide to assess a product's sustainability >](#)



Transparency RoHS/REACH

## Well-being performance

Mercury Free

Rohs Exemption Information Yes

## Certifications & Standards

Reach Regulation [REACH Declaration](#)

Eu Rohs Directive Compliant with Exemptions

China Rohs Regulation [China RoHS declaration](#)  
Product out of China RoHS scope. Substance declaration for your information

Environmental Disclosure [Product Environmental Profile](#)

Weee The product must be disposed on European Union markets following specific waste collection and never end up in rubbish bins

Circularity Profile [End of Life Information](#)

Dimensions and Drawings

LC1 F630 and F800

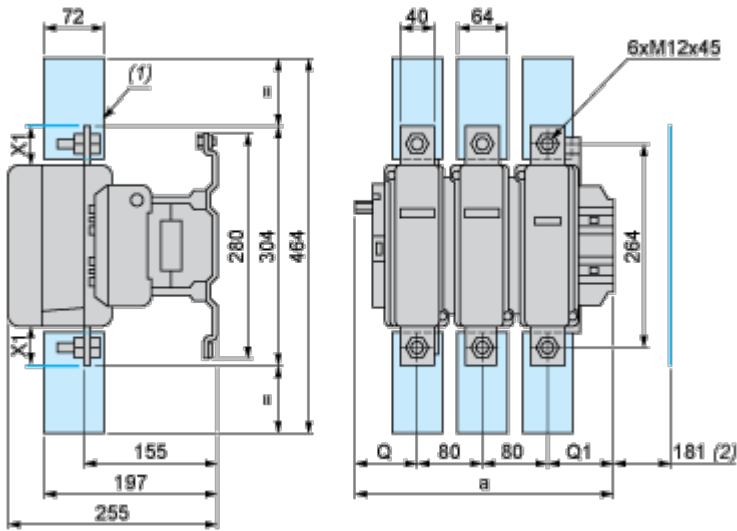

- (1) Power terminal protection shroud.
- (2) Minimum distance required for coil removal.

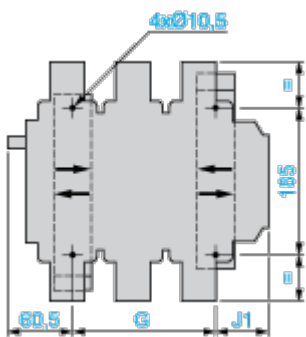

**NOTE:** X1 (mm) = Minimum electrical clearance according to operating voltage and breaking capacity.

LC1		a	G supplied	G min.	G max.	J1	Q	Q1
F630	2P	309	180	100	195	68.5	102	127
F630, F800	3P	309	180	100	195	68.5	60	89
F630	4P	389	240	150	275	88.5	60	89

Voltage	200...500 V	690...1000 V	200...690 V	1000 V
LC1 F630	20	30	-	-
LC1 F800	-	-	10	20

TeSys F reversing contactors and changeover contactor pairs Vertically mounted

**NOTE:** For customer assembly, with mechanical interlock (MI) LA9 F, fixing recommended on AM1 EC uprights (please consult your Regional Sales Office). 2 x LC1 identical or different ratings (LC1 F115 to F630 and F800).

Assembly A

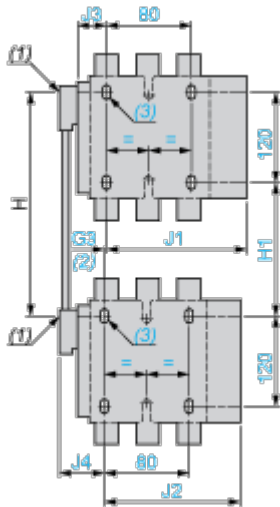

- (1) Mechanical interlock shaft.
- (2) For assembly of contactors of different ratings only.
- (3) 4 x Ø6.5 for LC1 F115 to F225.

Assembly A<sup>(7)</sup> - Mechanical interlock reference

	G3 3P	G3 4P	H min.	H max.	H1 min.	H1 max.	J1 3P	J1 4P
LA9 FF4F	0	0	200	310	80	190	137	155.5
LA9 FG4F	3	4	210	300	90	180	139.5	159.5
LA9 FG4G	0	0	220	310	100	190	139.5	159.5

	J2 3P	J2 4P	J3 3P	J3 4P	J4 3P	J4 4P
LA9 FF4F	137	155.5	48.5	67	48.5	67
LA9 FG4F	137	155.5	53	73	54	69
LA9 FG4G	139.5	159.5	53	73	53	73

Assembly B



	H1 min.	H1 max.	J1 3P	J1 4P	J2 3P	J2 4P	J4 3P	J4 4P
LA9 FL4G	150	220	248.5	328.5	139.5	159.5	53	73

Assembly C

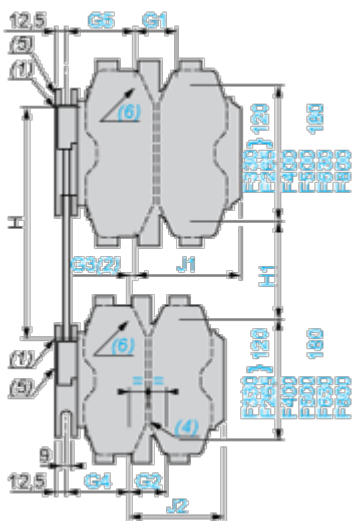

(6) 4 x Ø8.5 for LC1 F400, F500 or 4 x Ø10.5 for LC1 F630 and F800.

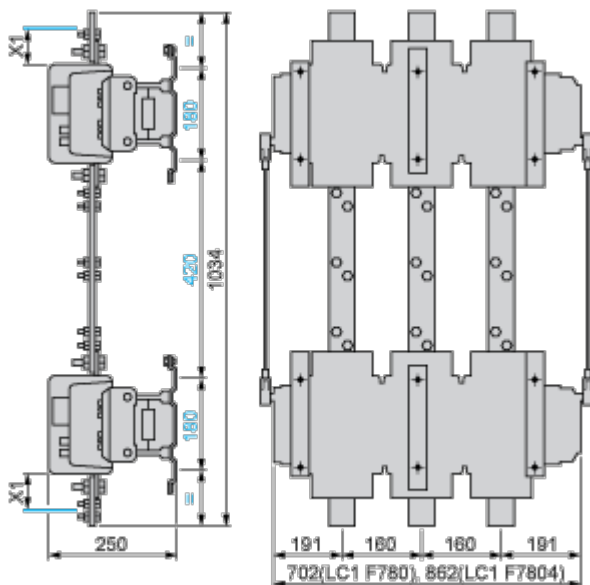

(7) Only 3P for F800.

(8) In this case, G4 is greater than G5.

Assembly C<sup>(7)</sup>

	G1 3P	G1 4P	G2 3P	G2 4P	G3 3P	G3 4P	G4 3P	G4 4P	G5 3P	G5 4P
LA9 FH4H	96	96	96	96	0	0	60	83	60	83
LA9 FJ4H	80	80	96	96	23	0	60	83	83	83
LA9 FK4H	80	140	96	96	23	0	60	83	83	83



	G1 3P	G1 4P	G2 3P	G2 4P	G3 3P	G3 4P	G4 3P	G4 4P	G5 3P	G5 4P
LA9 FL4H	180	240	96	96	14	g <sup>(8)</sup>	60	83	74	74
LA9 FJ4J	80	80	80	80	0	0	83	83	83	83
LA9 FK4J	80	140	80	80	0	0	83	83	83	83
LA9 FL4J	180	240	80	80	g <sup>(8)</sup>	g <sup>(8)</sup>	83	83	74	74
LA9 FK4K	80	140	80	140	0	0	83	83	83	83
LA9 FL4K	180	240	80	140	g <sup>(8)</sup>	g <sup>(8)</sup>	83	83	74	74
LA9 FL4L	180	240	180	240	0	0	74	74	74	74

	H min.	H max.	H1 min.	H1 max.	J1 3P	J1 4P	J2 3P	J2 4P
LA9 FH4H	250	380	130	260	157.5	181.5	157.5	181.5
LA9 FJ4H	260	380	110	230	144.5	192.5	157.5	181.5
LA9 FK4H	280	380	130	230	164.5	219.5	157.5	181.5
LA9 FL4H	330	380	170	220	248.5	328.5	157.5	181.5
LA9 FJ4J	260	380	60	200	144.5	192.5	144.5	192.5
LA9 FK4J	280	380	100	200	164.5	219.5	144.5	192.5
LA9 FL4J	325	380	140	195	248.5	329.5	144.5	192.5
LA9 FK4K	300	380	120	200	164.5	329.5	164.5	219.5
LA9 FL4K	345	380	160	195	248.5	328.5	164.5	219.5
LA9 FL4L	380	380	200	200	248.5	328.5	248.5	328.5

### Connections and Schema

---

#### 2, 3, and 4-pole Contactors

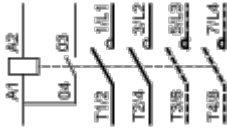

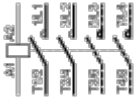

LC1 F115 to F630, F1250 (coil LX1 F )



LC1 F115 to F630 , F1250 (coil LX4 F )

LC1 F115 to F265 (coil LX9 F )

LC1 F800 (coil LX8 F  / )

